



AD-A142 043

DEPARTMENT OF DEFENCE  
DEFENCE SCIENCE AND TECHNOLOGY ORGANISATION  
AERONAUTICAL RESEARCH LABORATORIES

MELBOURNE, VICTORIA

*ARL/MECH-ENG-395*

MECHANICAL ENGINEERING NOTE-395

20000803103

A PARAMETRIC STUDY OF RAMROCKET  
PERFORMANCE

THE UNITED STATES NATIONAL  
TECHNICAL INFORMATION SERVICE  
IS AUTHORISED TO  
REPRODUCE AND SELL THIS REPORT

by  
LINCOLN ERM

Approved for Public Release

DTIC  
SELECTED  
JUN 14 1984  
A



Reproduced From  
Best Available Copy

FILE COPY

© COMMONWEALTH OF AUSTRALIA 1983

APRIL 1983

04 08 14 001

AERONAUTICAL RESEARCH LABORATORIES  
DEFENCE SCIENCE AND TECHNOLOGY ORGANISATION  
DEPARTMENT OF DEFENCE

MECHANICAL ENGINEERING NOTE 395

**A PARAMETRIC STUDY OF RAMROCKET  
PERFORMANCE**

by

LINCOLN ERM

**SUMMARY**

*The performance of a ramrocket having conventional solid propellant is calculated for a range of chosen operating conditions. The geometry of the ramrocket is allowed to vary to suit the flow conditions assumed. Both constant area and constant pressure mixing and combustion are considered. Performance curves in terms of thrust augmentation ratio are presented.*



© COMMONWEALTH OF AUSTRALIA 1983

---

POSTAL ADDRESS: Director, Aeronautical Research Laboratories,  
Box 4331, P.O., Melbourne, Victoria, 3001, Australia

## CONTENTS

	Page No.
NOTATION	
1. INTRODUCTION	1
2. FEATURES OF THEORETICAL MODEL	1
2.1 Principle of Operation	1
2.2 Propellant Properties and Secondary Combustion	1
2.3 Assumed Flow Conditions	1
3. EVALUATION OF FLOW VARIABLES	2
4. ANALYSIS OF RESULTS	2
4.1 Constant Area Mixing and Combustion	2
4.2 Constant Pressure Mixing and Combustion	3
4.3 Optimum Geometries	3
5. CONCLUSIONS	3
6. ACKNOWLEDGEMENT	4
REFERENCES	
APPENDIX I: ANALYSIS OF FLOW THROUGH RAMROCKET	
FIGURES	
DISTRIBUTION	
DOCUMENT CONTROL DATA	



Accession for	
NTIS GRA&I	<input checked="" type="checkbox"/>
NTIS TAB	<input type="checkbox"/>
Unannounced	<input type="checkbox"/>
Justification	
Distribution	
Availability Codes	
Dist	Special
A-1	

## NOTATION

<i>Symbol</i>	<i>Definition</i>
$A$	Flow area measured normal to flow direction. $m^2$
$M$	Mach number.
$\dot{m}$	Mass flow rate. kg/s
$P$	Total pressure. Pa
$p$	Static pressure. Pa
$R$	Gas constant. J/kg.K
$T$	Total temperature. K
$t$	Static temperature. K
$V$	Gas velocity. m/s
$\gamma$	Specific heat ratio.
$\mu$	Mass flow ratio = $\dot{m}_2/\dot{m}_1$
$\rho$	Density of gas. $kg/m^3$
$\tau$	Thrust augmentation ratio = $\frac{\text{Total net thrust}}{\text{Thrust of primary rocket in isolation}}$
$\tau^*$	Maximum value of $\tau$ obtained when $M_2$ is varied and $M_1$ and $\mu$ held constant.
$\tau^{**}$	Maximum value of $\tau^*$ obtained when $\mu$ is varied and $M_1$ held constant.
<i>Subscripts</i>	
A	Refers to atmospheric conditions.
1-4	Refers to flow stations 1 to 4 in Fig. 1.
<i>Superscripts</i>	
'	Refers to primary flow at station 2.
"	Refers to secondary flow at station 2.

## 1. INTRODUCTION

The appeal of air augmented rockets for weapon propulsion lies in their potential to go some way towards achieving the fuel efficiency of full air-breathing systems without forsaking the advantages of relative simplicity and cheapness offered by the use of solid propellants.

Initial work on the augmentor research programme at A.R.L. by Stewart *et al.* (1976) assessed the performance of a ramrocket system applied to a particular subsonic missile. More recent work has been concerned with simple non-afterburning augmentors for very low speed application (Fisher (1980), Fisher & Irvine (1981)).

The present report describes a parametric study of a ramrocket for a wider range of possible flight speeds and augmentor configurations than that of Stewart *et al.*, but with a somewhat simplified analysis. The purpose of the study was to gain an appreciation of the effects that varying different parameters had upon ramrocket internal performance, rather than to predict accurately absolute levels of performance.

## 2. FEATURES OF THEORETICAL MODEL

### 2.1 Principle of Operation

A diagrammatic representation of the idealised ramrocket used in the current investigation, showing stations along the flow path, is given in Fig. 1.

A solid-fueled rocket produces fuel-rich exhaust products which are expanded through the rocket nozzle into a mixing tube/combustion chamber. This primary flow mixes with secondary air flow delivered from the atmosphere by an intake/diffuser system, and further combustion takes place. The mixture is then expanded through the exhaust nozzle to atmosphere.

### 2.2 Propellant Properties and Secondary Combustion

The propellant considered was a composite type containing 75 per cent ammonium perchlorate, 20 per cent binder and 5 per cent aluminium. The temperature and pressure at the primary nozzle exit plane were  $T_2' = 2555$  K and  $P_2' = 5066$  kPa (50 atmospheres) respectively and other properties of the primary efflux were as given in Section A1.2.1 of Appendix I. The temperature rise resulting from combustion of the primary efflux and secondary air, as well as the gas constants of the final combustion product, were taken from the study of Stewart *et al.* (1976), who based these data on the computer programme of Gordon & McBride (1971). In that study only one flight Mach number (0.6) was considered, and the secondary combustion efficiency was assumed constant at 90 per cent for a range of secondary/primary mass flow ratios. The use of the same secondary combustion data in the present study neglected the effects on the combustion reaction of varying both ram pressure and air total temperature, but this was not thought to alter significantly the results of the study. This approach permitted the use of curves defining properties of the combustion products which were independent of all variables except mass flow ratio,  $\mu$ . These are shown in Fig. 2.

### 2.3 Assumed Flow Conditions

The analysis was simplified to the extent that the flow variables were assumed to be constant across the entire cross section at all stations except of course at station 2 where both the primary and secondary flow variables were assumed to be constant across their respective cross sections. This implied that mixing was complete at station 3. Ambient atmospheric conditions were assumed to correspond to sea level, and at station 4 the static pressure was assumed to be atmospheric. It was also assumed that no pre-entry diffusion occurred upstream of station 1.

Two different types of flow were considered. In one case the flow area between stations 2 and 3 was assumed to be constant, i.e.  $A_3 = A_2' + A_2''$ , while in the other case the flow was assumed to be at constant pressure, i.e.  $p_3 = p_2'$ . These are the only two cases that are mathematically simple.

### 3. EVALUATION OF FLOW VARIABLES

For selected values of  $M_1$ ,  $\mu$  and  $M_2'$ , flow variables throughout the ramrocket were evaluated in a step-by-step manner. A standard intake loss law was used to determine  $P_2'$ . Details of the primary jet at station 2 were known and values of  $(T_3 - T_2')$ ,  $\gamma_3$  and  $R_3$  corresponding to the selected value of  $\mu$  were obtained from Fig. 2. Equations for conservation of mass, momentum and energy were used in the analysis which is detailed in Appendix I.

The independent variables  $M_1$ ,  $\mu$  and  $M_2'$  were varied as shown in Table 1 and flow solutions were determined for different combinations of these variables. The intake duct, mixing tube/combustion chamber and exhaust nozzle were allowed to vary in shape to suit the flow conditions assumed.

TABLE 1  
Chosen Values of Independent Variables

Constant Area Mixing and Combustion				Constant Pressure Mixing and Combustion			
Independent Variable	Initial Value	Final Value	Step Size	Independent Variable	Initial Value	Final Value	Step Size
$M_1$	0.4	2.0	0.2	$M_1$	0.4	2.0	0.2
$\mu$	1.0	7.0	1.0	$\mu$	1.0	7.0	1.0
$M_2'$	0.040	Not specified*	0.002†	$M_2'$	0.040	1.000	0.002†

\* Final value of  $M_2'$  corresponds approximately to onset of sonic flow at station 3.

† Smallest step size used.

Performance was calculated in terms of thrust augmentation ratio,  $\tau$ . This was regarded as being a more useful performance parameter than, say, specific impulse, in a situation where the air-breathing system was being studied as an augmentor for a conventional rocket at flight speeds not conducive to very high levels of performance. It will be seen, for example, that in some instances  $\tau$  was less than unity.

### 4. ANALYSIS OF RESULTS

#### 4.1 Constant Area Mixing and Combustion

In order to assess how  $\tau$  varied as  $M_2'$  and  $\mu$  were changed while  $M_1$  was held constant, plots were made of  $\tau$  versus  $M_2'$  for different values of  $\mu$  for the selected value of  $M_1$ . Altogether nine different plots of this type were made corresponding to  $M_1 = 0.4$  to  $M_1 = 2.0$  in steps of 0.2. Only the plots corresponding to  $M_1 = 0.4$ , 1.2 and 2.0 are presented. These are shown in Figs. 3, 4 and 5 respectively.

The right hand extremities of the  $\tau$  versus  $M_2'$  curves on the nine plots indicate the points beyond which it was impossible to obtain solutions, due to choking of the flow at station 3. Loci corresponding to the onset of choked conditions are shown in Figs. 3, 4 and 5.

#### 4.2 Constant Pressure Mixing and Combustion

Data for the constant pressure case are shown in Figs. 6, 7 and 8. These figures correspond to Figs. 3, 4 and 5 respectively for the constant area case. For the constant pressure case, flow solutions were obtained for all values of  $M_2^*$  chosen.

#### 4.3 Optimum Geometries

Although in general the foregoing results show that the level of augmentation ratio for a given flight speed and mass flow ratio is not very sensitive to the degree of diffusion in the intake system, particularly for constant pressure mixing and combustion, there is nevertheless an optimum value of  $\tau$  for each case. The optimum values are in fact the same for both constant area and constant pressure mixing and combustion, and occur at the same value of  $M_2^*$  and for the same geometry. In other words, for a given flight speed and mass flow ratio, the best constant area geometry is also a constant pressure one and vice-versa. The values of  $M_2^*$  corresponding to the best geometries lie within the range 0.11 to 0.19.

To eliminate  $M_2^*$  as a variable for the constant area case, maximum values of  $\tau$ , i.e. values of  $\tau^*$ , associated with each value of  $\mu$  were determined from each  $\tau$  versus  $M_2^*$  plot and plotted against  $\mu$  for different values of  $M_1$  as shown in Fig. 9. It follows from earlier discussion that Fig. 9 applies equally to the constant pressure case. It can be seen that maximum values of  $\tau^*$  occur when  $\mu$  is within the range 6.0 to 7.0 for all values of  $M_1$ .

Maximum values of  $\tau^*$ , i.e. values of  $\tau^{**}$ , associated with each value of  $M_1$ , were determined from Fig. 9 and plotted against  $M_1$  as shown in Fig. 10. This curve indicates the maximum value of  $\tau$  that can be obtained for a given flight speed and clearly shows how augmentor performance improves as flight speed increases.

Optimum geometries for  $M_1 = 0.4, 1.2$  and  $2.0$  are depicted diagrammatically in Fig. 11 in order to gain some insight into the effects on geometry of Mach number variation. Dimensions in the streamwise direction have been normalised so as to facilitate a comparison between the optimum geometries. The proportioning of the lengths of the intake duct, mixing tube and nozzle has been chosen somewhat arbitrarily, but it is thought to be realistic. It is to be noted, however, that streamwise dimensions have no bearing on the analysis.

### 5. CONCLUSIONS

A simplified analysis was used to calculate the thrust augmentation ratio,  $\tau$ , of a ramrocket for a range of operating conditions and for the mixing and combustion processes taking place at both constant area and constant pressure. For all chosen flight speeds and for both the constant area and constant pressure cases, the performance of the ramrocket, for a given value of  $M_2^*$ , improved as the mass flow ratio increased to a value within the range  $\mu = 6.0$  to  $\mu = 7.0$ . For all combinations of  $M_1$  and  $\mu$  chosen, it was shown that the optimum configuration for both the constant area and constant pressure cases was the same. The highest calculated value of  $\tau$  increased from 1.11 for  $M_1 = 0.4$ , to 2.43 for  $M_1 = 2.0$ , for optimum configurations featuring both constant area and constant pressure mixing and combustion.

## **6. ACKNOWLEDGEMENT**

The author wishes to acknowledge gratefully the valuable contributions of Mr. S. A. Fisher, who supervised the study and provided guidance, many helpful suggestions and continued support.



#### REFERENCES

- Fisher, S. A. "Thrust Augmenting Ejectors for High Pressure Ratio Propulsive Jets." Institution of Engineers, Australia, Seventh Australasian Conference on Hydraulics and Fluid Mechanics, Brisbane, Australia, 1980.
- Fisher, S. A. and Irvine, R. D. "Air Augmentation of Rockets for Low Speed Application." Fifth International Symposium on Air Breathing Engines, Bangalore, India, 1981.
- Gordon, S. and McBride, B. J. "Computer Program for Calculation of Complex Chemical Equilibrium Compositions, Rocket Performance, Incident and Reflected Shocks, and Chapman-Jouguet Detonations." NASA SP-273, 1971.
- Stewart, D. G., Frith, D. A., Fisher, S. A. and Bradfield, W. A. "Thrust Augmentation by Air Induction and Afterburning in Subsonic Rocket Propelled Vehicles." Third International Symposium on Air Breathing Engines, Munich, West Germany, 1976.

## APPENDIX I

### A.1 ANALYSIS OF FLOW THROUGH RAMROCKET

For selected values of  $M_1$ ,  $\mu$  and  $M_2'$ , flow conditions throughout the ramrocket were evaluated. The equations used are presented below.

#### A1.1 Flow at Station 1

The known flow variables at station 1 were the independent variable  $M_1$  and also variables corresponding to sea-level ambient conditions, viz.  $t_1 = 288$  K,  $p_1 = 101$  kPa,  $\gamma_1 = 1.4$  and  $R_1 = 287$  J/kg.K.

Other flow variables were determined as follows:

$$\dot{m}_1 = \mu \dot{m}_2' \quad (\text{A1.1})$$

$$T_1 = t_1 \left[ 1 + \frac{(\gamma_1 - 1)}{2} M_1^2 \right] \quad (\text{A1.2})$$

$$P_1 = p_1 \left[ 1 + \frac{(\gamma_1 - 1)}{2} M_1^2 \right]^{\gamma_1 / (\gamma_1 - 1)} \quad (\text{A1.3})$$

$$V_1 = M_1 \sqrt{[\gamma_1 R_1 t_1]} \quad (\text{A1.4})$$

$$\rho_1 = \frac{p_1}{R_1 t_1} \quad (\text{A1.5})$$

$$A_1 = \frac{\dot{m}_1}{\rho_1 V_1} \quad (\text{A1.6})$$

#### A1.2 Flow at Station 2

##### A1.2.1 Primary Flow

The temperature, pressure, Mach number and gas properties of the primary flow were taken to be as follows:  $T_2' = 2555$  K,  $P_2' = 5066$  kPa (50 atmospheres),  $M_2' = 3.0$ ,  $\gamma_2' = 1.244$  and  $R_2' = 365$  J/kg.K.

Equations used to determine other flow variables are given below:

$$t_2' = \frac{T_2'}{\left[ 1 + \frac{(\gamma_2' - 1)}{2} M_2'^2 \right]} \quad (\text{A1.7})$$

$$p_2' = \frac{P_2'}{\left[ 1 + \frac{(\gamma_2' - 1)}{2} M_2'^2 \right]^{\gamma_2' / (\gamma_2' - 1)}} \quad (\text{A1.8})$$

$$\rho_2' = \frac{p_2'}{R_2' t_2'} \quad (\text{A1.9})$$

$$V_2' = M_2' \sqrt{[\gamma_2' R_2' t_2']} \quad (\text{A1.10})$$

$$A_2' = \frac{\dot{m}_2'}{\rho_2' V_2'} \quad (\text{A1.11})$$

### A1.2.2 Secondary Flow

For the secondary flow,  $M_2^*$  was a known independent variable and  $P_2^*$  was calculated from an empirical intake loss law as follows:

$$P_2^* = P_1 \quad (0.0 < M_1 \leq 1.0) \quad (\text{A1.12})$$

$$P_2^* = P_1(1.0 - 0.076(M_1 - 1.0)^{1.35}) \quad (1.0 < M_1 < 5.0) \quad (\text{A1.13})$$

Other equations used are as follows:

$$\gamma_2^* = \gamma_1 \quad (\text{A1.14})$$

$$R_2^* = R_1 \quad (\text{A1.15})$$

$$\dot{m}_2^* = \mu \dot{m}_1^* \quad (\text{A1.16})$$

$$T_2^* = T_1 \quad (\text{A1.17})$$

$$t_2^* = \frac{T_2^*}{\left[1 + \frac{(\gamma_2^* - 1)}{2} M_2^{*2}\right]} \quad (\text{A1.18})$$

$$p_2^* = \frac{P_2^*}{\left[1 + \frac{(\gamma_2^* - 1)}{2} M_2^{*2}\right]^{\gamma_2^*/(\gamma_2^* - 1)}} \quad (\text{A1.19})$$

$$\rho_2^* = \frac{p_2^*}{R_2^* t_2^*} \quad (\text{A1.20})$$

$$V_2^* = M_2^* \sqrt{[\gamma_2^* R_2^* t_2^*]} \quad (\text{A1.21})$$

$$A_2^* = \frac{\dot{m}_2^*}{\rho_2^* V_2^*} \quad (\text{A1.22})$$

### A1.3 Flow at Station 3

#### A1.3.1 Constant Area Mixing and Combustion

The values of  $T_3$ ,  $\gamma_3$  and  $R_3$  were determined using Fig. 2.

For constant area mixing and combustion,  $A_3$  was determined from

$$A_3 = A_2 + A_1^* \quad (\text{A1.23})$$

In order to evaluate  $M_3$ , the equations for conservation of mass and momentum between stations 2 and 3 were used. These equations are

$$\dot{m}_3 = \dot{m}_2 + \dot{m}_1^* \quad (\text{A1.24})$$

and

$$\dot{m}_2 V_2^* + p_2^* A_2 + \dot{m}_1^* V_1^* + p_1^* A_1^* = \dot{m}_3 V_3 + p_3 A_3 \quad (\text{A1.25})$$

After manipulation, the following equation containing  $M_3$  can be derived.

$$\frac{\dot{m}_2^*(V_2^* + \mu V_1^*) + p_2^* A_2 + p_1^* A_1^*}{\dot{m}_2^*(1 + \mu)} = \frac{M_3^2 \gamma_3 + 1}{M_3 \sqrt{\left[\frac{\gamma_3}{R_3 T_3} \left[1 + \frac{(\gamma_3 - 1)}{2} M_3^2\right]\right]}} \quad (\text{A1.26})$$

It is possible to rearrange this equation and obtain an explicit expression for  $M_3$ . However, because of the complexity of the expression, it is not given here.

Equations used to determine other flow variables are as follows

$$t_3 = \frac{T_3}{\left[1 + \frac{(\gamma_3 - 1)}{2} M_3^2\right]} \quad (\text{A1.27})$$

$$p_3 = \frac{\dot{m}_3}{A_3 M_3 \sqrt{\left[\frac{R_3 t_3}{\gamma_3}\right]}} \quad (\text{A1.28})$$

$$P_3 = p_3 \left[1 + \frac{(\gamma_3 - 1)}{2} M_3^2\right]^{\gamma_3 / (\gamma_3 - 1)} \quad (\text{A1.29})$$

$$V_3 = M_3 \sqrt{[\gamma_3 R_3 t_3]} \quad (\text{A1.30})$$

$$\rho_3 = \frac{p_3}{R_3 t_3} \quad (\text{A1.31})$$

### A1.3.2 Constant Pressure Mixing and Combustion

The values of  $T_3$ ,  $\gamma_3$  and  $R_3$  were once again determined using Fig. 2. For constant pressure mixing and combustion,  $p_3$  was determined from

$$p_3 = p_2^* \quad (\text{A1.32})$$

In order to evaluate  $V_3$ , the equations for conservation of mass and momentum between stations 2 and 3 were used. These equations are

$$\dot{m}_3 = \dot{m}_2' + \dot{m}_2'' \quad (\text{A1.33})$$

and

$$\dot{m}_2' V_2' + p_2' A_2' + \dot{m}_2'' V_2'' + p_2'' (A_3 - A_2'') = \dot{m}_3 V_3 + p_3 A_3 \quad (\text{A1.34})$$

After manipulation, the following expression for  $V_3$  can be derived

$$V_3 = \frac{\dot{m}_2' V_2' + p_2' A_2' + \dot{m}_2'' V_2'' - p_2'' A_2''}{\dot{m}_2' + \dot{m}_2''} \quad (\text{A1.35})$$

Other equations used are given below

$$t_3 = T_3 - \frac{(\gamma_3 - 1) V_3^2}{2 \gamma_3 R_3} \quad (\text{A1.36})$$

$$M_3 = \sqrt{\left[\frac{2}{(\gamma_3 - 1)} \left[\frac{T_3}{t_3} - 1\right]\right]} \quad (\text{A1.37})$$

$$P_3 = p_3 \left[1 + \frac{(\gamma_3 - 1)}{2} M_3^2\right]^{\gamma_3 / (\gamma_3 - 1)} \quad (\text{A1.38})$$

$$\rho_3 = \frac{p_3}{R_3 t_3} \quad (\text{A1.39})$$

$$A_3 = \frac{\dot{m}_3}{\rho_3 V_3} \quad (\text{A1.40})$$

### A1.4 Flow at Station 4

The value of  $p_4$  corresponds to ambient conditions, i.e.  $p_4 = 101 \text{ kPa}$ . Equations used to determine other flow variables are given below

$$\gamma_4 = \gamma_3 \quad (\text{A1.41})$$

$$R_4 = R_3 \quad (\text{A1.42})$$

$$\dot{m}_4 = \dot{m}_3 \quad (\text{A1.43})$$

$$T_4 = T_3 \quad (\text{A1.44})$$

$$P_4 = P_3 \quad (\text{A1.45})$$

$$M_4 = \sqrt{\left[ \frac{2}{(\gamma_4 - 1)} \left[ \left\{ \frac{P_4}{P_3} \right\}^{(\gamma_4 - 1)/\gamma_4} - 1 \right] \right]} \quad (\text{A1.46})$$

$$t_4 = \frac{T_4}{\left[ 1 + \frac{(\gamma_4 - 1)}{2} M_4^2 \right]} \quad (\text{A1.47})$$

$$V_4 = M_4 \sqrt{[\gamma_4 R_4 t_4]} \quad (\text{A1.48})$$

$$\rho_4 = \frac{P_4}{R_4 t_4} \quad (\text{A1.49})$$

$$A_4 = \frac{\dot{m}_4}{\rho_4 V_4} \quad (\text{A1.50})$$

#### A1.5 Thrust Augmentation Ratio

The thrust augmentation ratio was determined as follows:

$$\tau = \frac{\dot{m}_4 V_4 - \dot{m}_1 V_1}{(p_2 - p_A) A_2 + \dot{m}_2 V_2} \quad (\text{A1.51})$$

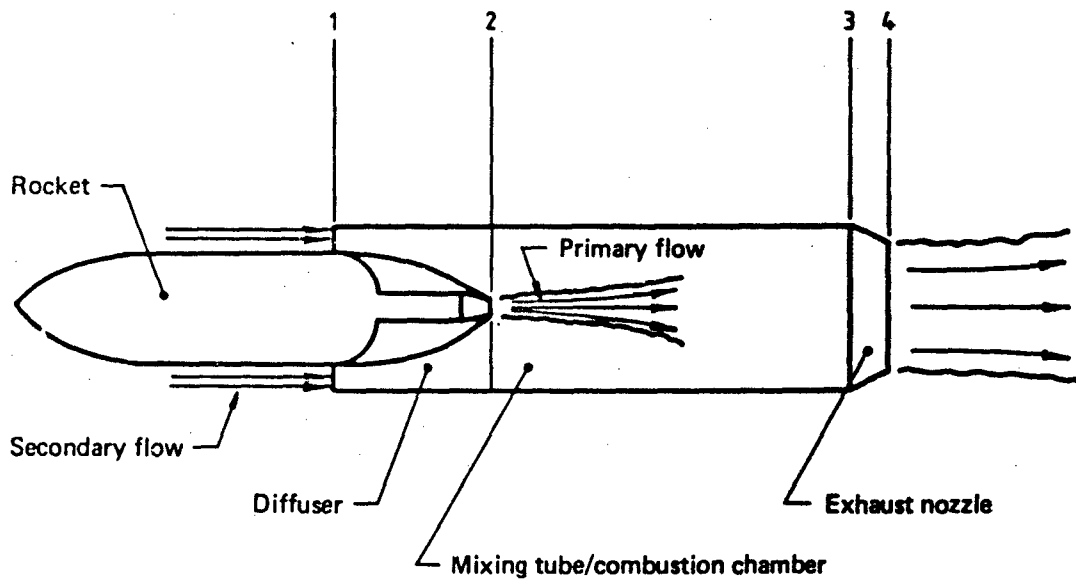

FIG. 1 DIAGRAMMATIC REPRESENTATION OF RAMROCKET SHOWING STATIONS ALONG FLOW PATH

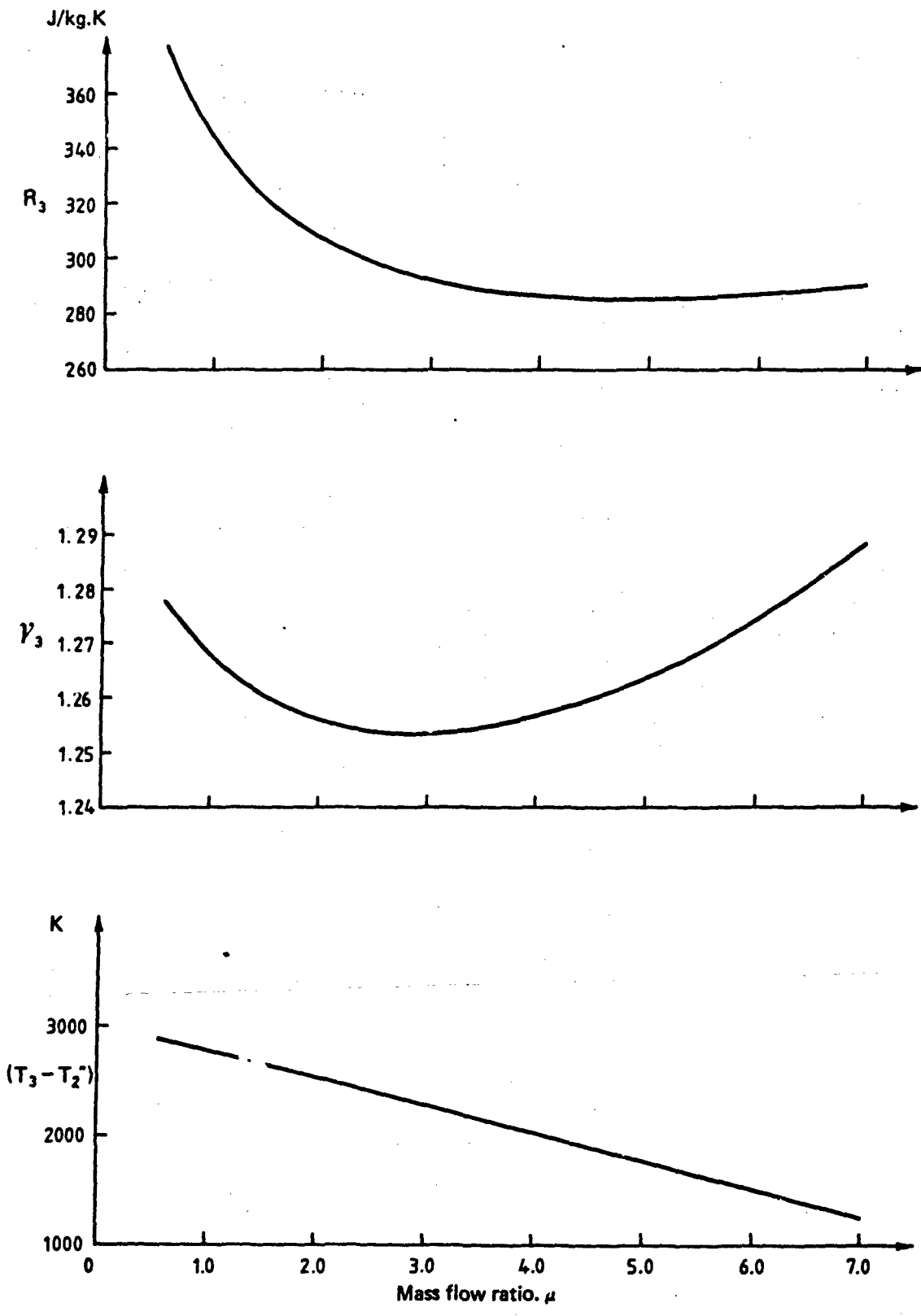

FIG. 2 CURVES USED TO DETERMINE PROPERTIES OF COMBUSTION PRODUCTS AT STATION 3.

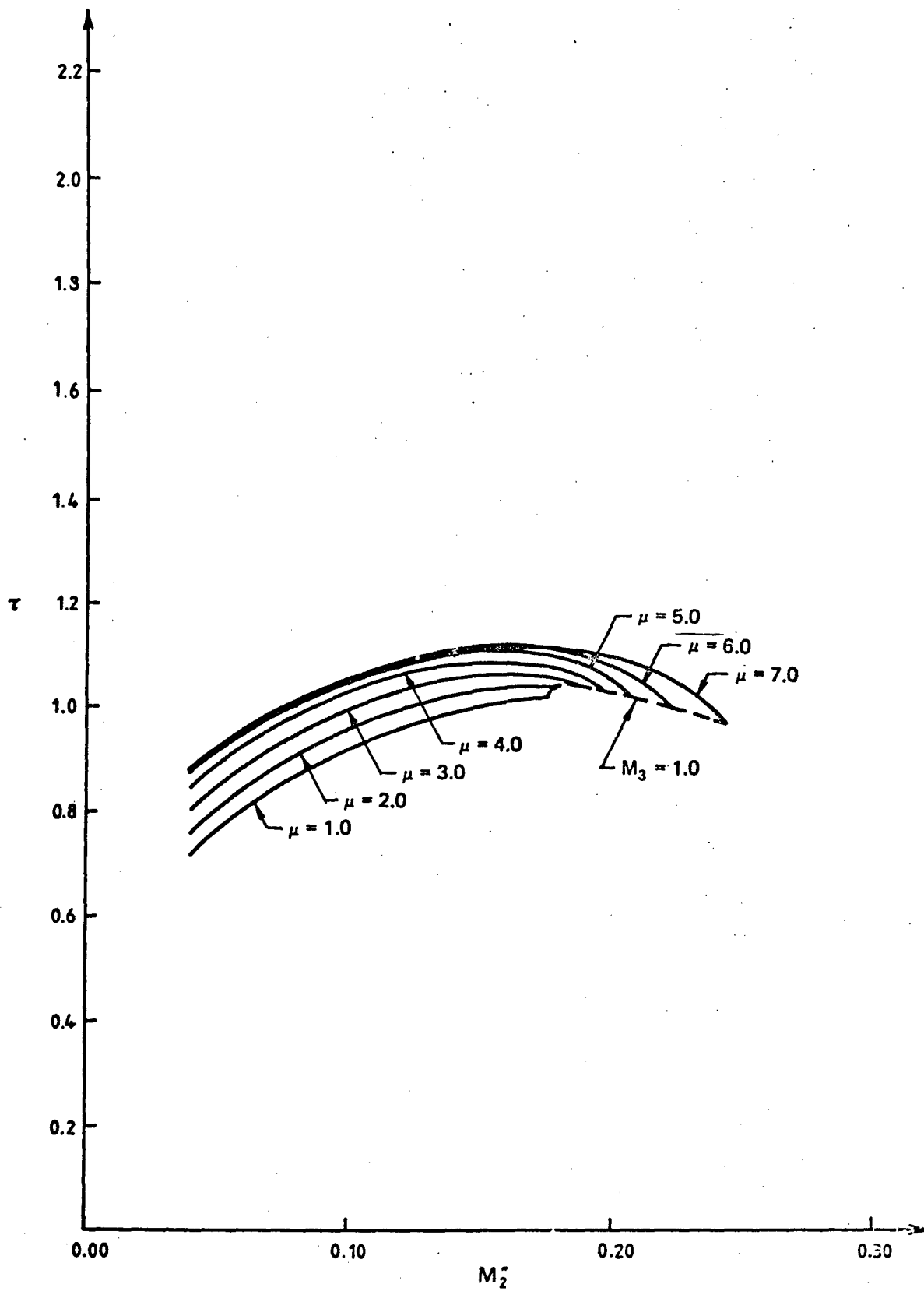

FIG. 3  $\tau$  VERSUS  $M_2^2$  for  $M_1 = 0.4$  AND CONSTANT AREA MIXING AND COMBUSTION



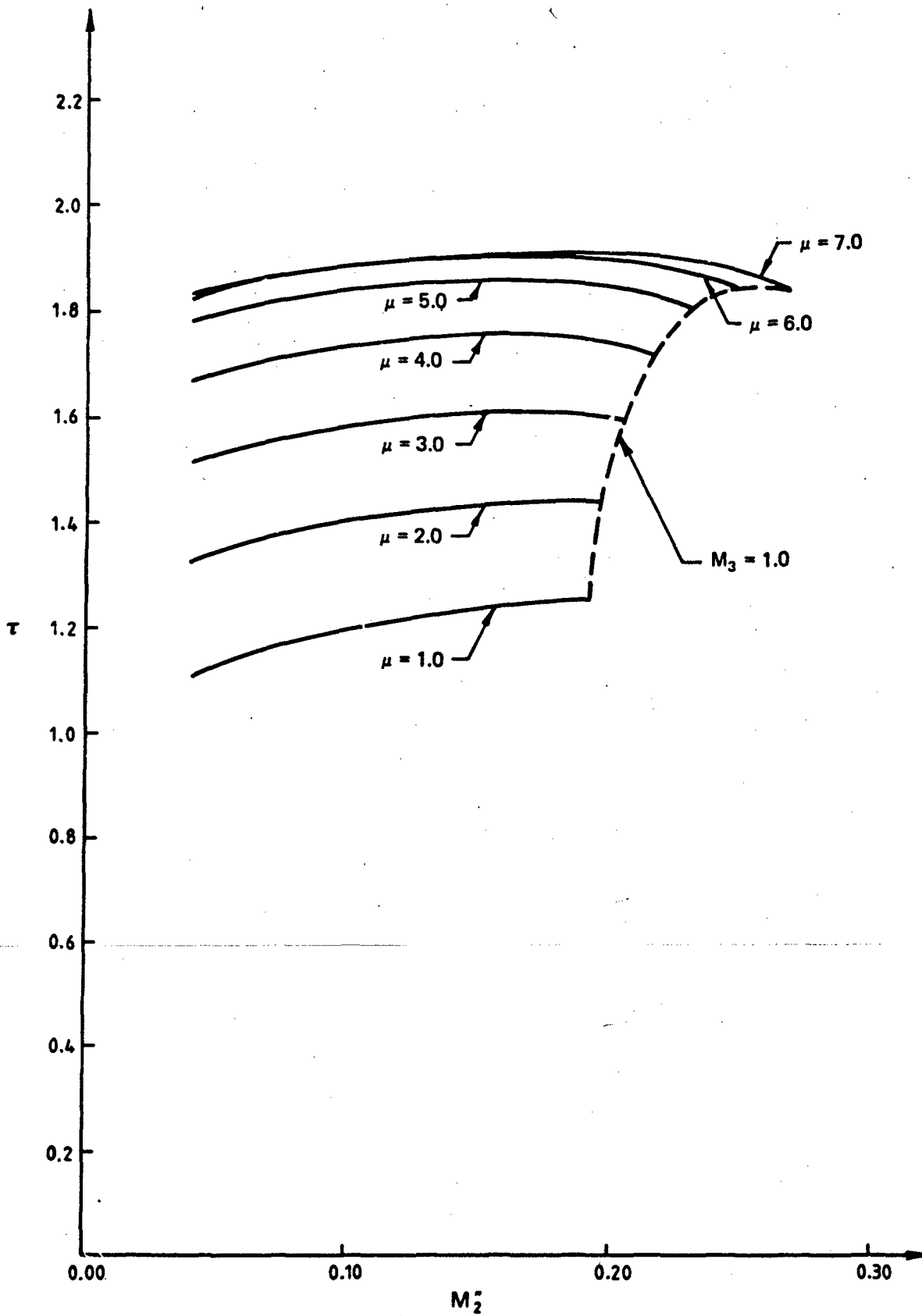

FIG. 4  $\tau$  VERSUS  $M_2^2$  FOR  $M_1 = 1.2$  AND CONSTANT AREA MIXING AND COMBUSTION.

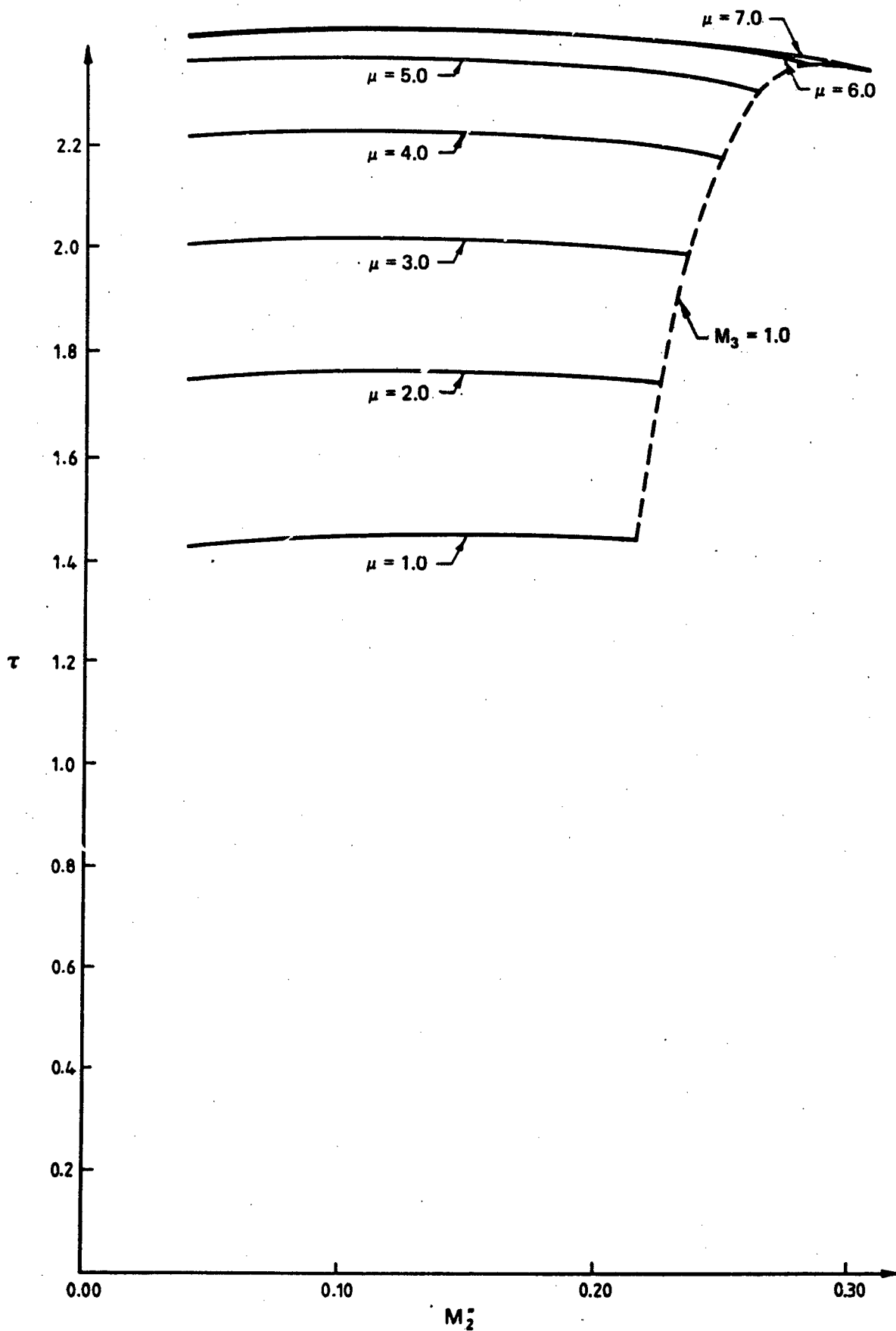

FIG. 5  $\tau$  VERSUS  $M_2$  for  $M_1 = 2.0$  AND CONSTANT AREA MIXING AND COMBUSTION.

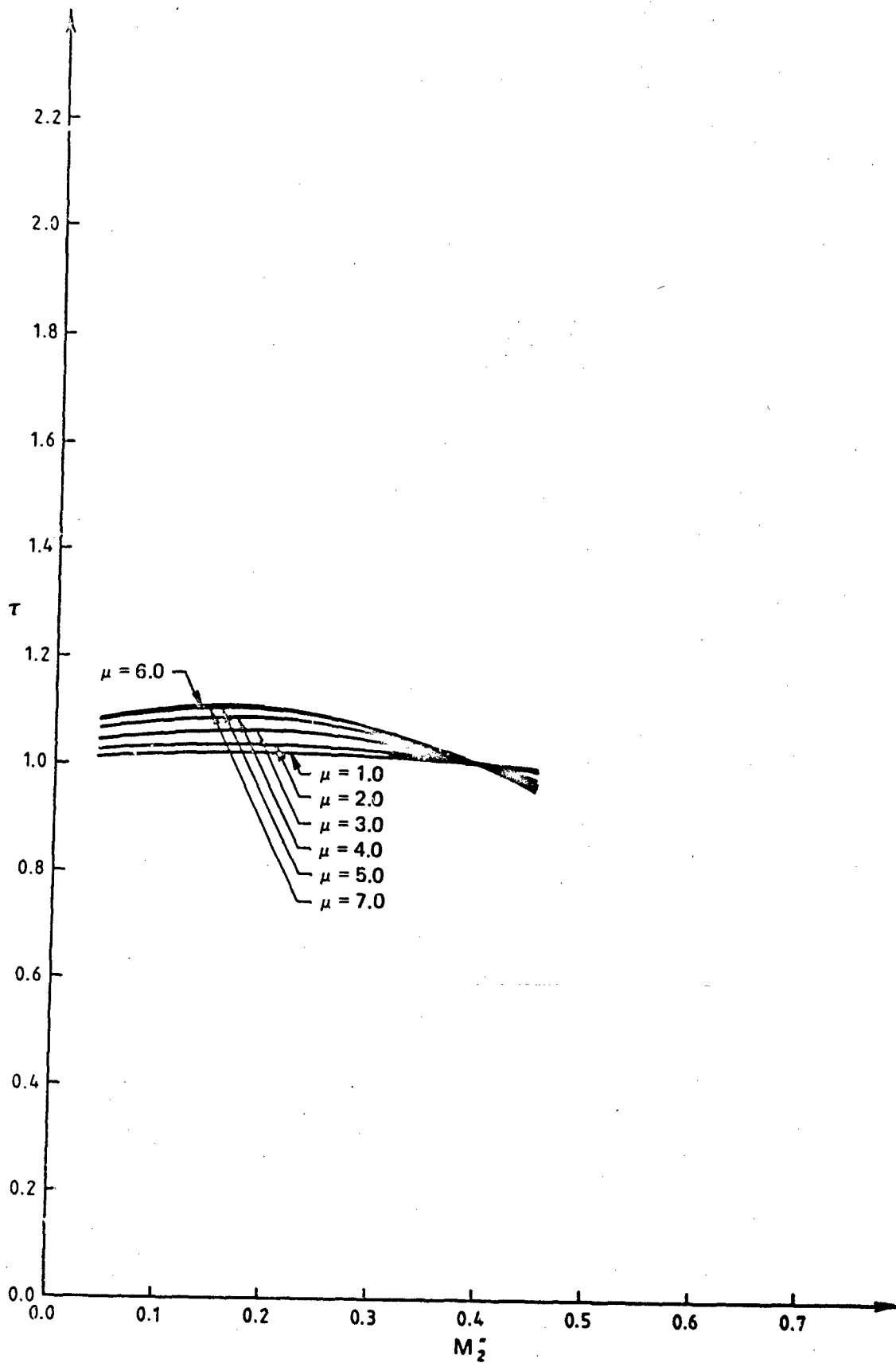

FIG. 6  $\tau$  VERSUS  $M_2$  FOR  $M_1 = 0.4$  AND CONSTANT PRESSURE MIXING AND COMBUSTION.

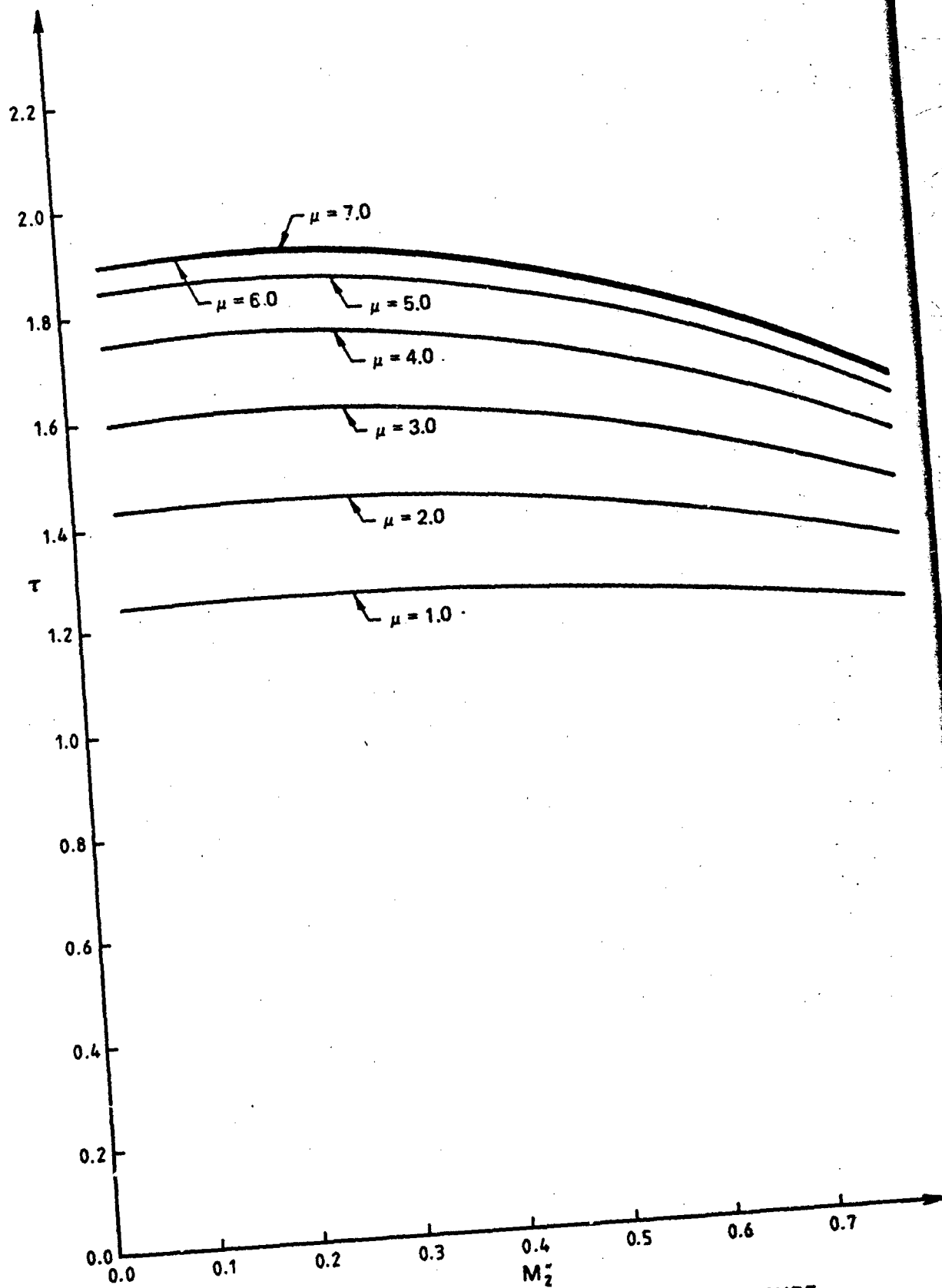

FIG. 7  $\tau$  VERSUS  $M_2$  FOR  $M_1 = 1.2$  AND CONSTANT PRESSURE MIXING AND COMBUSTION.

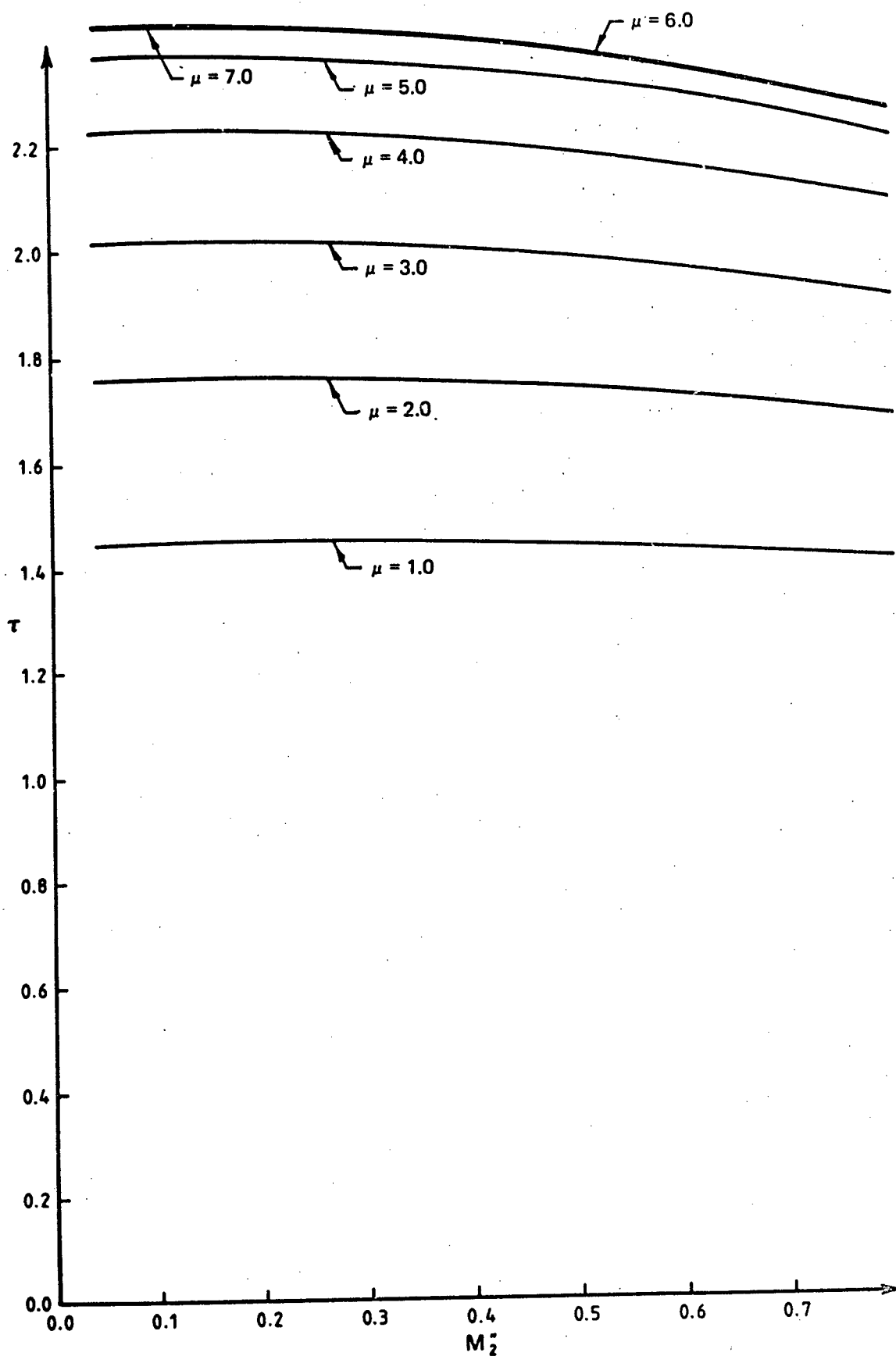

FIG. 8  $\tau$  VERSUS  $M_2^2$  FOR  $M_1 = 2.0$  AND CONSTANT PRESSURE MIXING AND COMBUSTION.

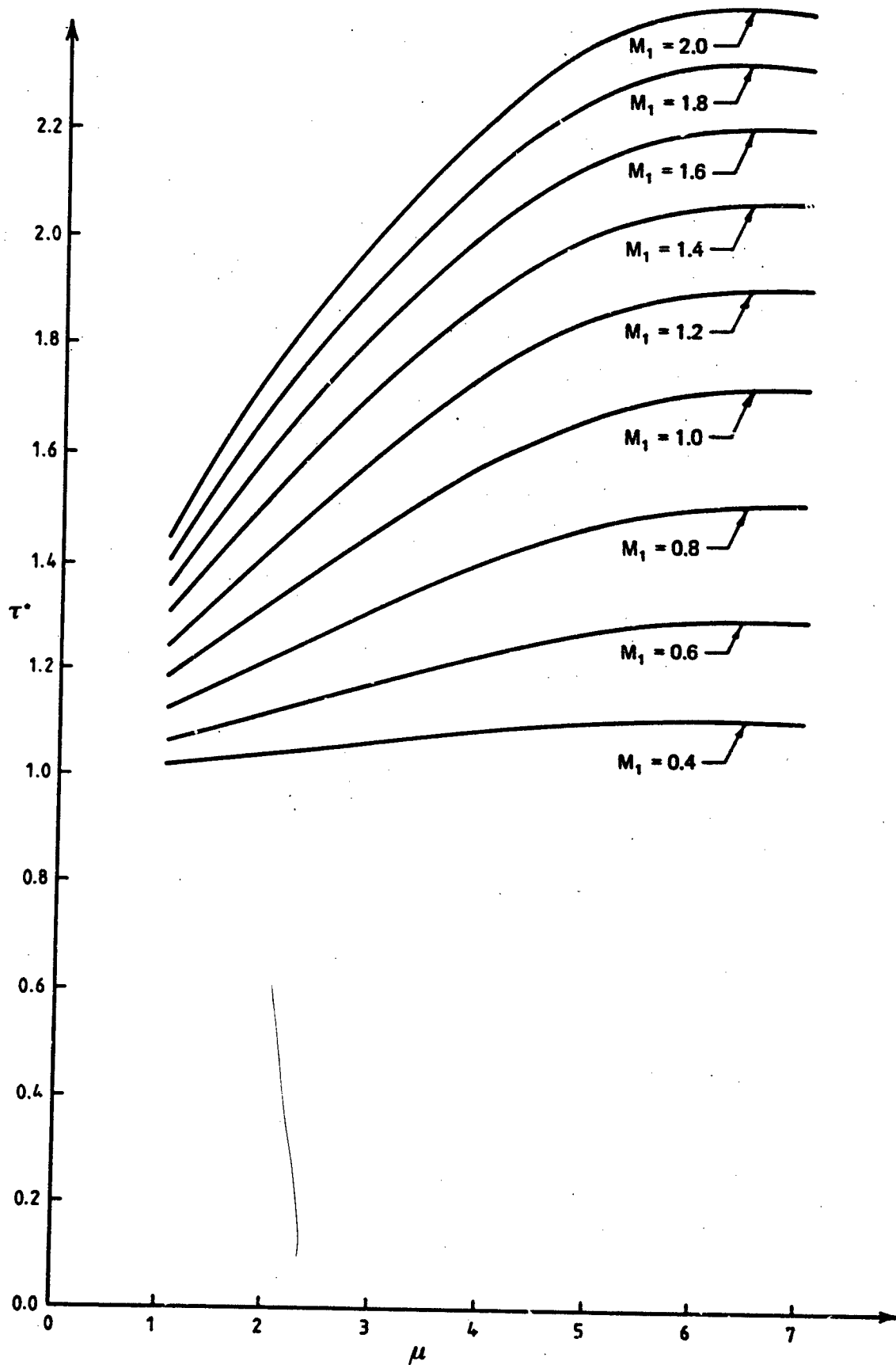

FIG. 9  $\tau^*$  VERSUS  $\mu$  FOR BOTH CONSTANT AREA AND CONSTANT PRESSURE MIXING AND COMBUSTION.

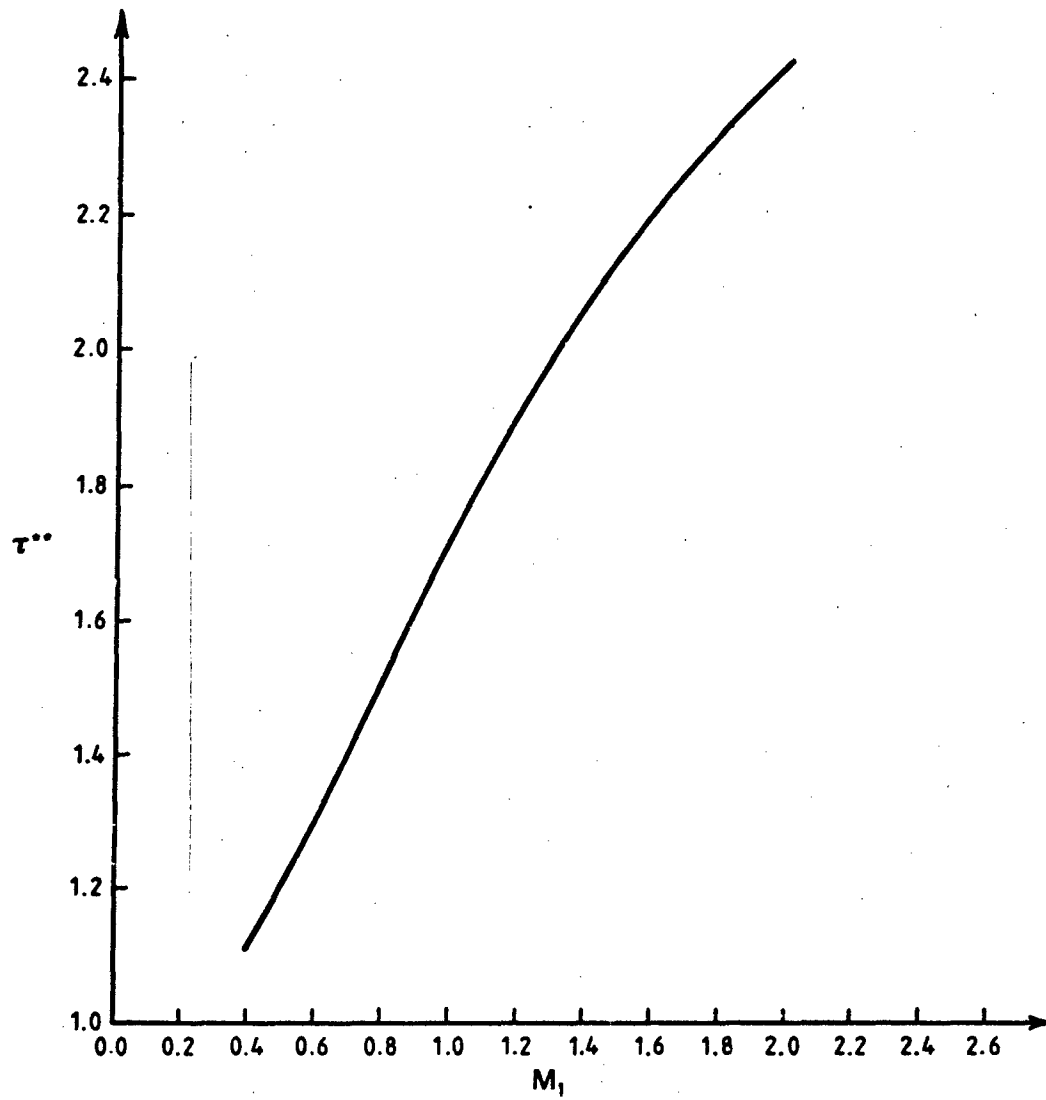

FIG. 10  $\tau^{**}$  VERSUS  $M_1$  FOR BOTH CONSTANT AREA AND CONSTANT PRESSURE MIXING AND COMBUSTION.

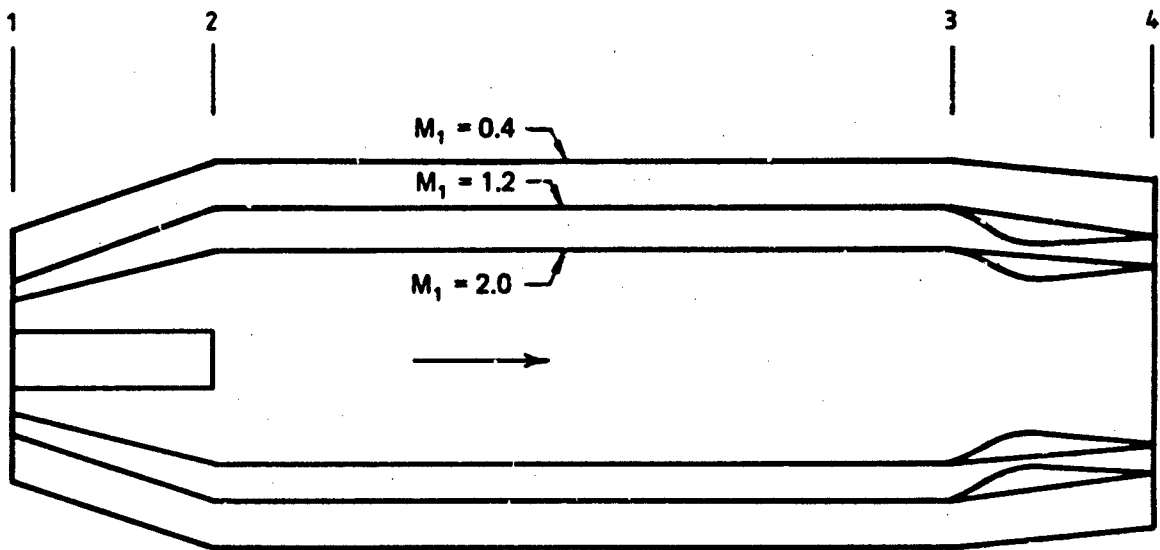

FIG. 11 DIAGRAMMATIC REPRESENTATION OF OPTIMUM GEOMETRIES FOR  $M_1 = 0.4, 1.2$  and  $2.0$ .



## DISTRIBUTION

### AUSTRALIA

#### DEPARTMENT OF DEFENCE

##### Central Office

Chief Defence Scientist  
Deputy Chief Defence Scientist  
Superintendent, Science and Technology Programmes  
Controller, Projects and Analytical Studies  
Defence Science Representative (U.K.) (Doc. Data Sheet only)  
Counsellor, Defence Science (U.S.A.) (Doc. Data Sheet only)  
Defence Central Library  
Document Exchange Centre, D.I.S.B. (17 copies)  
Joint Intelligence Organisation  
Librarian H Block, Victoria Barracks, Melbourne  
Director General—Army Development (NSO) (4 copies)

##### Aeronautical Research Laboratories

Director  
Library  
Superintendent—Mechanical Engineering  
Divisional File—Mechanical Engineering  
Author: L. P. Erm  
S. A. Fisher  
W. H. Harch

##### Materials Research Laboratories

Director/Library

##### Defence Research Centre

Library  
W. H. Jolley  
J. F. Hooper

##### Navy Office

Navy Scientific Adviser

##### Army Office

Army Scientific Adviser  
Engineering Development Establishment, Library

##### Air Force Office

Air Force Scientific Adviser  
WEAPENG 2—AF

##### Central Studies Establishment

Information Centre

**DEPARTMENT OF DEFENCE SUPPORT**  
**Government Aircraft Factories**  
**Library**

**Universities and Colleges**

Adelaide	Barr Smith Library
Flinders	Library
Latrobe	Library
Melbourne	Engineering Library
Monash	Hargrave Library
Newcastle	Library
Sydney	Engineering Library
N.S.W.	Physical Sciences Library
Queensland	Library
Tasmania	Engineering Library
Western Australia	Library
R.M.I.T.	Library

**CANADA**

**NRC**

Aeronautical & Mechanical Engineering Library  
Gas Dynamics Laboratory, Mr R. A. Tyler

**FRANCE**

ONERA, Library

**GERMANY**

Fachinformationszentrum: Energie, Physik, Mathematik GMBH

**INDIA**

Defence Ministry, Aero Development Establishment, Library  
Gas Turbine Research Establishment, Director  
Hindustan Aeronautics Ltd, Library  
National Aeronautical Laboratory, Information Centre

**ISRAEL**

Technion-Israel Institute of Technology      Professor J. Singer

**ITALY**

Professor Ing. Guiseppe Gabrielli

**JAPAN**

Institute of Space and Aeronautical Science, Library

**Universities**

Kagawa University      Professor. H. Ishikawa

**NETHERLANDS**

National Aerospace Laboratory (NLR), Library

**NEW ZEALAND**

Defence Scientific Establishment, Library  
RNZAF, Vice Consul (Defence Liaison)

**Universities**

Canterbury Library

**SWEDEN**

Swedish National Defense Research Institute (FOA)

**SWITZERLAND**

Armament Technology and Procurement Group

**UNITED KINGDOM**

CAARC, Secretary (NPL)  
Royal Aircraft Establishment  
Bedford, Library  
National Gas Turbine Establishment  
Director, Pyestock North  
British Library, Lending Division  
Rolls-Royce Ltd  
Aero Division Bristol, Library

**Universities and Colleges**

Bristol	Engineering Library
Cambridge	Whittle Library
Manchester	Professor N. Johannesen, Fluid Mechanics
Nottingham	Science Library
Southampton	Library
Strathclyde	Library
Cranfield Institute of Technology	Library

**UNITED STATES OF AMERICA**

NASA Scientific and Technical Information Facility  
Applied Mechanics Reviews  
United Technologies Corporation, Library  
McDonnell Aircraft Company, Library

**Universities and Colleges**

Johns Hopkins	Professor S. Corrsin, Engineering
Massachusetts Institute of Technology	M.I.T. Libraries

Spares (20 copies)

(Total 110 copies)

Department of Defence  
**DOCUMENT CONTROL DATA**

1. a. AR No. AR-002-949	1. b. Establishment No. ARL-MECH-ENG-NOTE-395	2. Document Date April, 1983	3. Task No. DST 82/049
4. Title A PARAMETRIC STUDY OF RAMROCKET PERFORMANCE		5. Security a. document Unclassified	6. No. Pages 12
		b. title    c. abstract U            U	7. No. Refs 4
8. Author(s) L. P. ERM		9. Downgrading Instructions —	
10. Corporate Author and Address Aeronautical Research Laboratories PO Box 4331, Melbourne, Vic., 3001		11. Authority (as appropriate) a. Sponsor                    c. Downgrading b. Security                    d. Approval	
12. Secondary Distribution (of this document) Approved for Public Release			
Overseas enquirers outside stated limitations should be referred through ASDIS, Defence Information Services Branch, Department of Defence, Campbell Park, CANBERRA, ACT, 2601.			
13. a. This document may be ANNOUNCED in catalogues and awareness services available to . . . No Limitations			
13. b. Citation for other purposes (i.e. casual announcement) may be (select) unrestricted (or) as for 13 a.			
14. Descriptors Ramrockets Thrust augmentation Parametric analysis		15. COSATI Group 2101 2108 2109	
16. Abstract <i>The performance of a ramrocket having conventional solid propellant is calculated for a range of chosen operating conditions. The geometry of the ramrocket is allowed to vary to suit the flow conditions assumed. Both constant area and constant pressure mixing and combustion are considered. Performance curves in terms of thrust augmentation ratio are presented.</i>			